



**DEPARTMENT OF THE AIR FORCE  
HEADQUARTERS 10TH AIR BASE WING  
USAF ACADEMY COLORADO**

6 April 2020

MEMORANDUM FOR ALL USAFA PERSONNEL

FROM: 10 ABW/CC

SUBJECT: USAFA Guidance on the Use of Cloth Face Coverings

References: (a) Secretary of Defense Memorandum, "Department of Defense Guidance on the Use of Cloth Face Coverings," 5 April 2020  
(b) CS316353B, Center for Disease Control Face Covering Fact Sheet, 4 April 20

1. Effective immediately, per the Secretary of Defense's direction in Reference (a), to the extent practical without significantly impacting mission, all individuals on DoD property, installations, and facilities are required to wear cloth face coverings when they cannot maintain six feet of physical distance in public areas or work centers (This does not include or apply to a service member/family member's personal residence on a military installation).
2. In order to slow the spread of the coronavirus disease 2019 (COVID-19) virus, The Centers for Disease Control and Prevention (CDC) recommends wearing cloth face coverings in public settings where other physical distancing measures are difficult to maintain, especially in areas of significant community-based transmission. Military personnel, civilian employees, their family members, and contractors are strongly encouraged to follow CDC guidelines on the use of cloth face coverings when off installation.
3. There is a nation-wide shortage of medical masks, such as surgical masks or N-95 masks. So the issue of these masks in place of a cloth face covering is not authorized, unless you are a healthcare worker in a medical setting, or a first responder answering a call.
4. Units must adhere to the five elements of military professional standards: neatness, cleanliness, safety, uniformity, and military image. Commanders will ensure face coverings worn by uniformed military members are conservative, professional, and in keeping with dignity and respect. Any cloth items worn as face coverings (i.e., neck gaiters, neck warmers, balaclavas, etc.) should be functional, cleaned, and maintained in compliance with current Air Force instructions and should cover the mouth and nose. As safety is the primary concern, until issued items are fully available, Commanders and units may deviate in regard to uniformity while maintaining other standards.
5. You can make your mask for little to no cost by following the instructions included in Attachment 1. Use good judgment when selecting the cloth, opting for subdued, solid colors and avoiding objectionable prints.
6. The cloth masks are useful for stopping droplets that are sprayed from the mouth or nose of the individual wearing the mask. It is not nearly as useful in preventing the wearer from inhaling droplets from other people, so it is important that even with a mask, that you continue to follow current physical distancing and hand hygiene protocols. Personnel wearing a cloth mask or face covering should ensure they clean their hands before adjusting the mask.
7. Thank you for doing your part in preventing the spread of COVID-19 virus. If you have any questions, please contact Col Ramon Yambo-Arias at [ramon.yamboarias.mil@mail.mil](mailto:ramon.yamboarias.mil@mail.mil).

BRIAN S. HARTLESS, Colonel, USAF  
Commander

Attachments:

Atch 1 - Coronavirus disease 2019 (COVID-19) Face Covering Fact sheet

# Use of Cloth Face Coverings to Help Slow the Spread of COVID-19

## How to Wear Cloth Face Coverings

Cloth face coverings should—

- fit snugly but comfortably against the side of the face
- be secured with ties or ear loops
- include multiple layers of fabric
- allow for breathing without restriction
- be able to be laundered and machine dried without damage or change to shape

## CDC on Homemade Cloth Face Coverings

CDC recommends wearing cloth face coverings in public settings where other social distancing measures are difficult to maintain (e.g., grocery stores and pharmacies), **especially** in areas of significant community-based transmission.

CDC also advises the use of simple cloth face coverings to slow the spread of the virus and help people who may have the virus and do not know it from transmitting it to others. Cloth face coverings fashioned from household items or made at home from common materials at low cost can be used as an additional, voluntary public health measure.

Cloth face coverings should not be placed on young children under age 2, anyone who has trouble breathing, or is unconscious, incapacitated or otherwise unable to remove the cloth face covering without assistance.

The cloth face coverings recommended are not surgical masks or N-95 respirators. Those are critical supplies that must continue to be reserved for healthcare workers and other medical first responders, as recommended by current CDC guidance.

## Should cloth face coverings be washed or otherwise cleaned regularly? How regularly?

Yes. They should be routinely washed depending on the frequency of use.

## How does one safely sterilize/clean a cloth face covering?

A washing machine should suffice in properly washing a cloth face covering.

## How does one safely remove a used cloth face covering?

Individuals should be careful not to touch their eyes, nose, and mouth when removing their cloth face covering and wash hands immediately after removing.

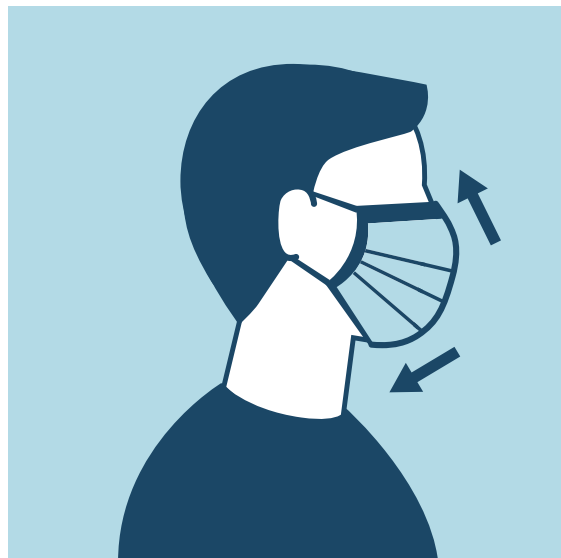

# Sewn Cloth Face Covering

## Materials

- Two 10"x6" rectangles of cotton fabric
- Two 6" pieces of elastic (or rubber bands, string, cloth strips, or hair ties)
- Needle and thread (or bobby pin)
- Scissors
- Sewing machine

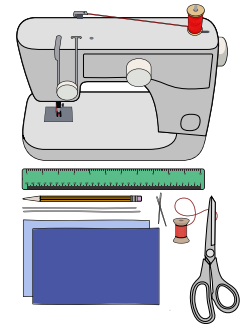

## Tutorial

1. Cut out two 10-by-6-inch rectangles of cotton fabric. Use tightly woven cotton, such as quilting fabric or cotton sheets. T-shirt fabric will work in a pinch. Stack the two rectangles; you will sew the cloth face covering as if it was a single piece of fabric.

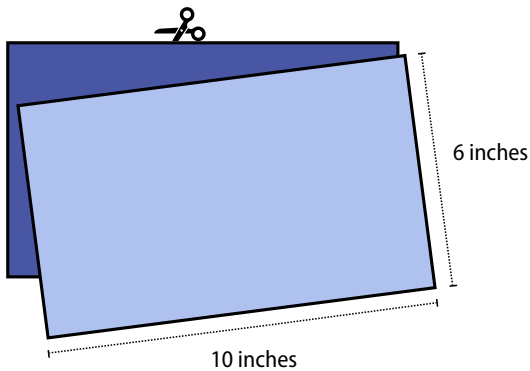

2. Fold over the long sides  $\frac{1}{4}$  inch and hem. Then fold the double layer of fabric over  $\frac{1}{2}$  inch along the short sides and stitch down.

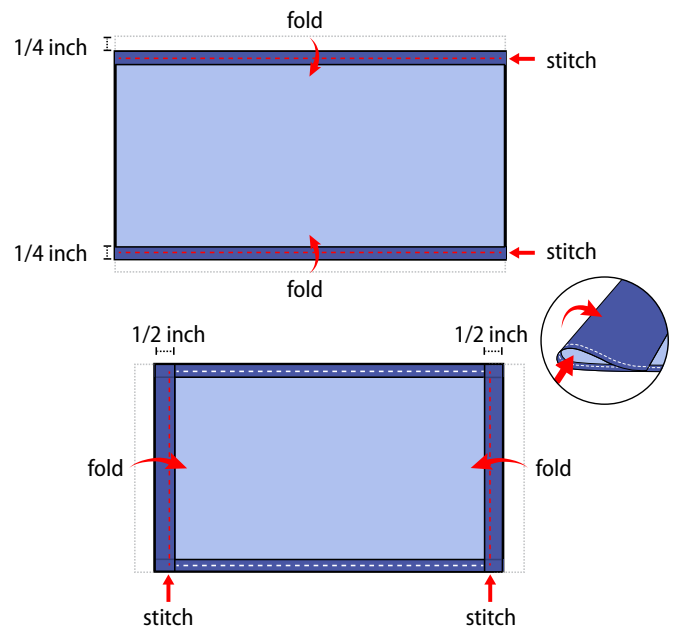

3. Run a 6-inch length of  $\frac{1}{8}$ -inch wide elastic through the wider hem on each side of the cloth face covering. These will be the ear loops. Use a large needle or a bobby pin to thread it through. Tie the ends tight. Don't have elastic? Use hair ties or elastic head bands. If you only have string, you can make the ties longer and tie the cloth face covering behind your head.

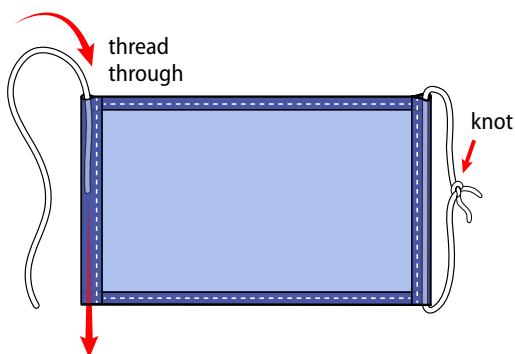

4. Gently pull on the elastic so that the knots are tucked inside the hem. Gather the sides of the cloth face covering on the elastic and adjust so the cloth face covering fits your face. Then securely stitch the elastic in place to keep it from slipping.

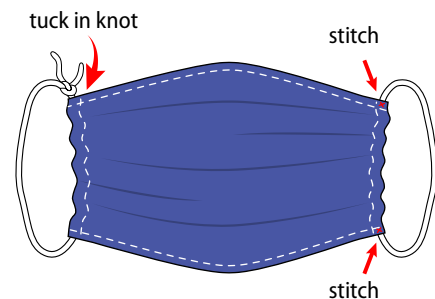

# Quick Cut T-shirt Cloth Face Covering (no sew method)

## Materials

- T-shirt
- Scissors

## Tutorial

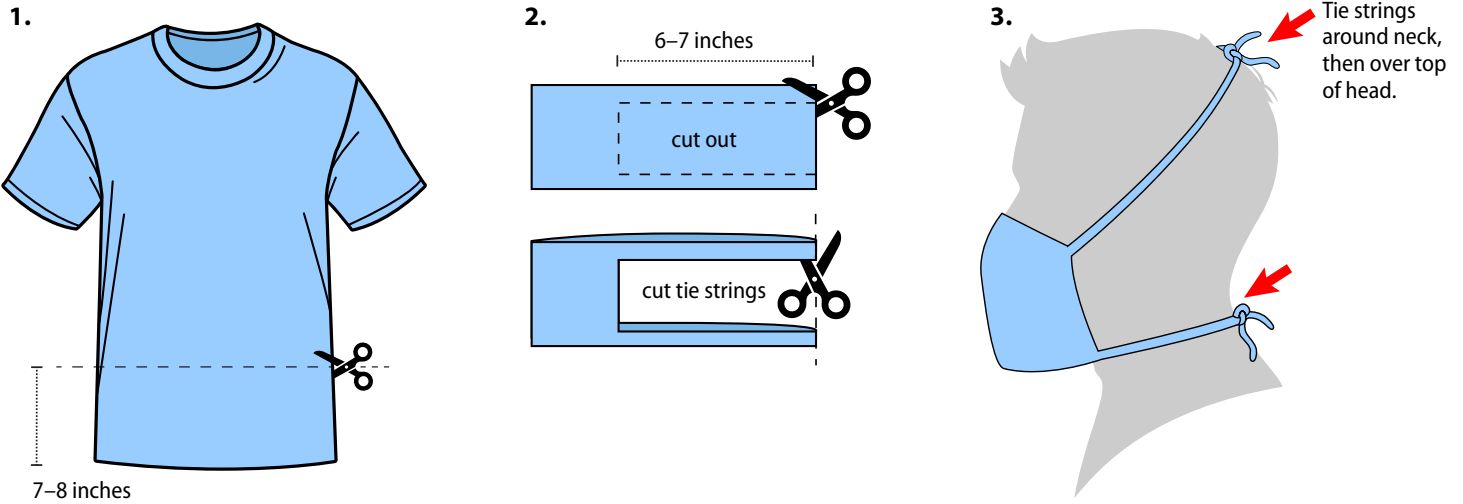

# Bandana Cloth Face Covering (no sew method)

## Materials

- Bandana (or square cotton cloth approximately 20"x20")
- Coffee filter
- Rubber bands (or hair ties)
- Scissors (if you are cutting your own cloth)

## Tutorial

